



INCLUDING
ACOUSTIC
SOLUTIONS

SWITZERLAND



SWISSCLIC PANEL

Wand- und Deckenlösungen |
Wall- and Ceiling Solutions

Holz in Bestform • Wood at its best

 **SWISS KRONO**



ECO FRIENDLY

SWISSCLIC SYSTEM 4

SWISSCLIC PANEL-A+ 4

SWISSCLIC PANEL-S 5

SWISSCLIC PANEL-A 6

SWISSCLIC ELEMENT-A 7

ACOUSTIC SOLUTION 8

DECORS 12

DESIGN 12

WOOD 18

ACCESSORIES 24

TOOLS 27

INSTALLATION GUIDE 28

PACKING UNITS 30

OVERVIEW 31

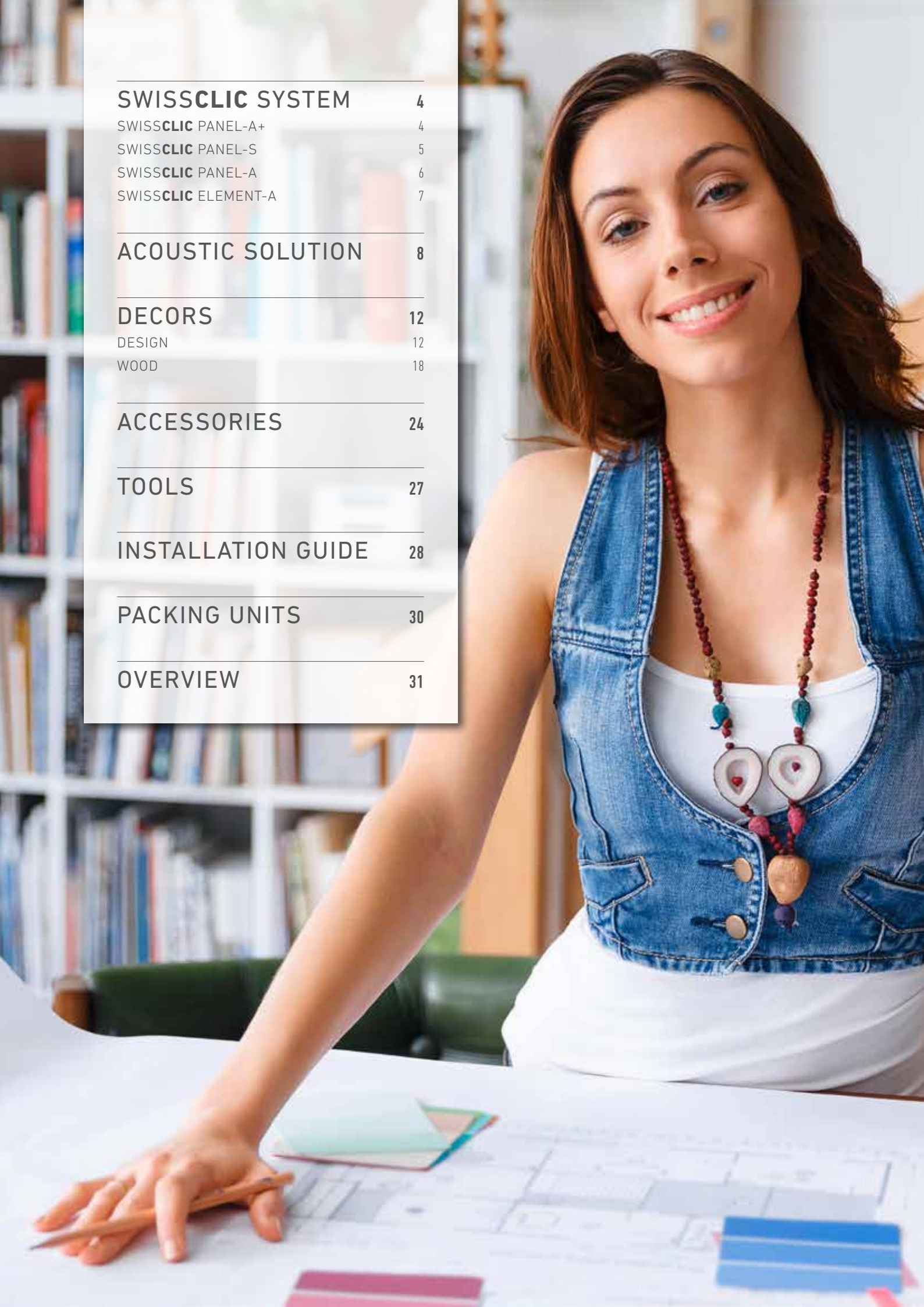

SWISSCLIC SYSTEM

SWISSCLIC PANEL-A+

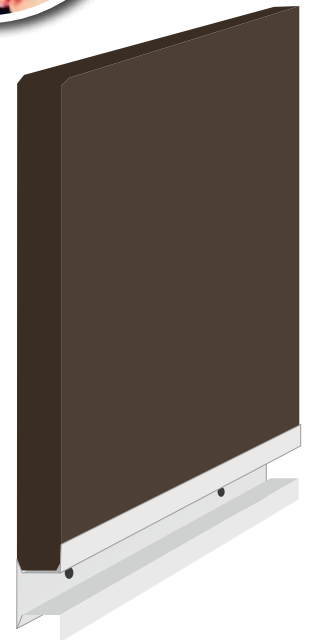
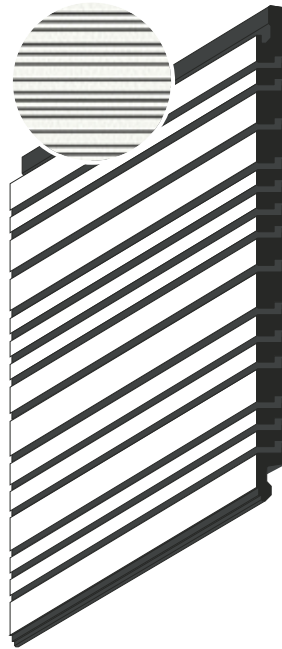
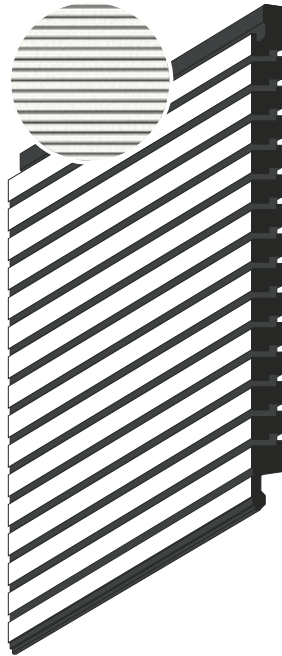

SWISSCLIC PANEL-A+ ELEGANT

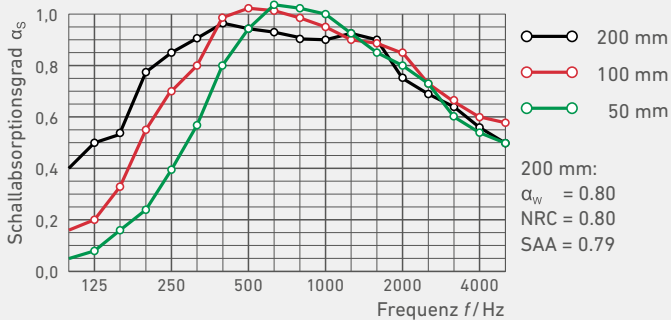

SWISSCLIC PANEL-A+ CREATIVE

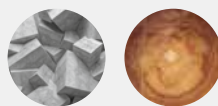
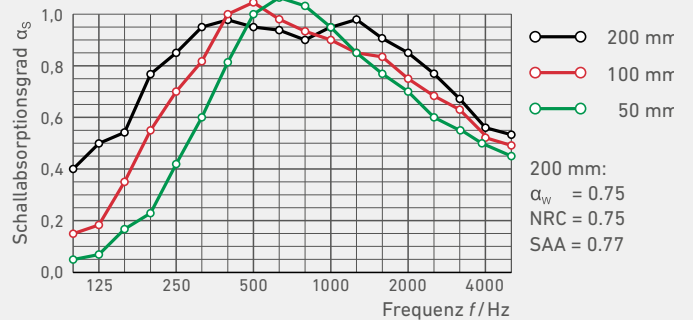

AVAILABLE IN
DESIGN | WOOD



SWISSCLIC PANEL-S

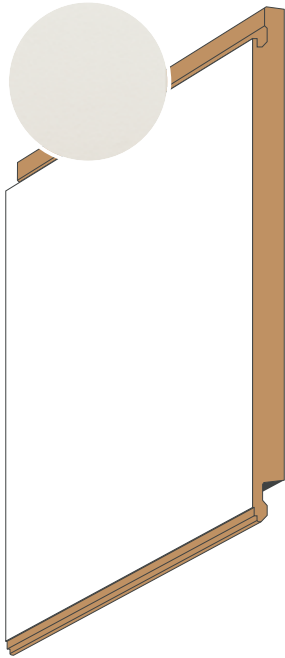

10 mm 0.4 "	1380 mm 54.33 "	187 mm 7.36 "

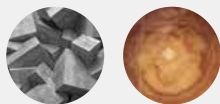

AVAILABLE IN
DESIGN | WOOD

SWISSCLIC SYSTEM

SWISSCLIC PANEL-A

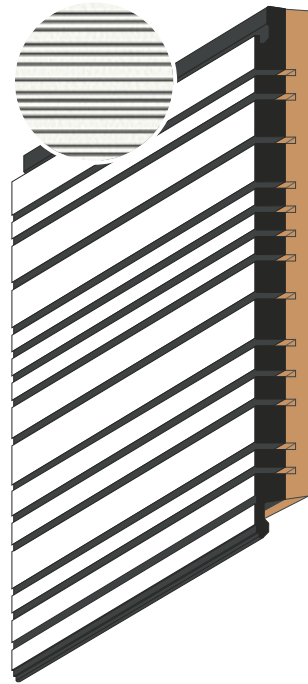
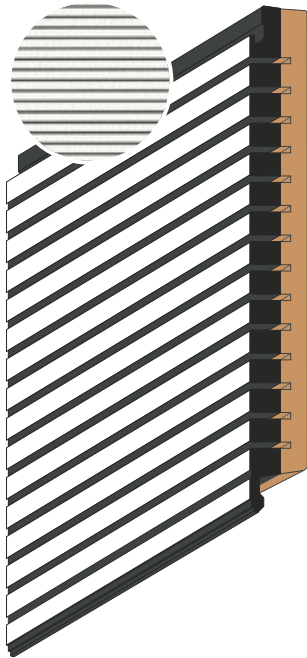

SWISSCLIC PANEL-A ELEGANT

SWISSCLIC PANEL-A CREATIVE

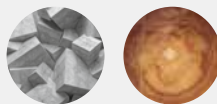
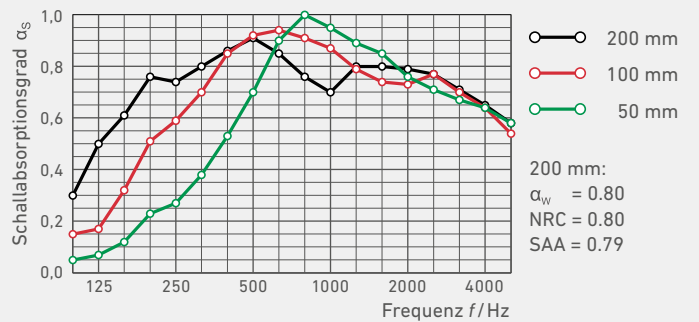
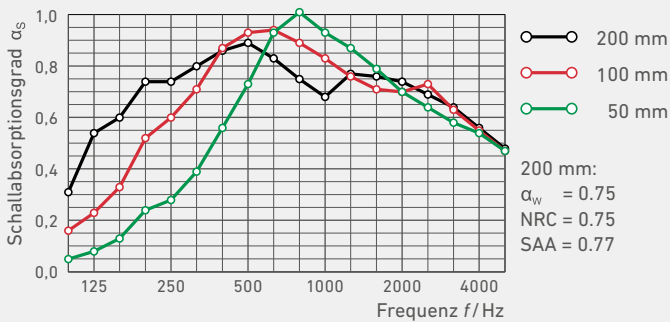

AVAILABLE IN
DESIGN | WOOD

SWISSCLIC ELEMENT-A

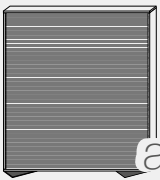

acoustic
element



acoustic
element
swiss digital

- DE** Bausatz zum selber Zusammenbauen.
- FR** Kit pour assembler soi-même.
- IT** Kit per montaggio autonomo.
- EN** Kit for self installation.
- ES** Kit para el ensamblaje en su casa.
- PT** Kit para automontagem.

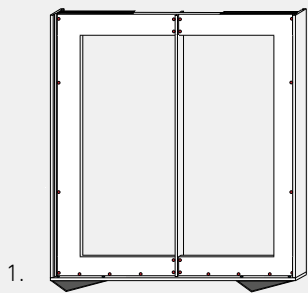

1.

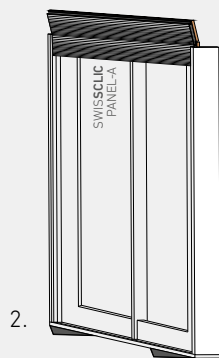

2.

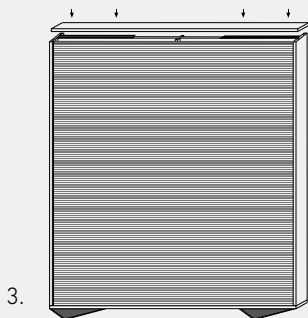

3.



Ihr Logo
Votre logo
Vostro logo
Your logo

Ihr Design
Votre design
Vostro design
Your design

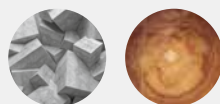

AVAILABLE IN
DESIGN | WOOD

ACOUSTIC SOLUTION

FACTS

DE 60-70%...

... der Schüler verstehen die Lehrer nicht richtig!
... der Büroangestellten sind überzeugt, dass sich ihre Produktivität steigert und die Fehlerquote kleiner wird, wenn man den Lärm in ihrer Umgebung reduziert.
... der Angestellten in Grossraumbüros empfinden Lärm als den grössten Störfaktor.

FR 60-70%...

... des élèves ne comprennent pas leurs professeurs!
... des employés de bureau sont convaincus que leur productivité augmente et le taux d'erreur diminue, si l'on réduit le bruit dans leur environnement.
... des employés dans les grands bureaux trouvent que le bruit est le facteur perturbant le plus important.

IT 60-70%...

... gli studenti non capiscono bene i loro insegnanti!
... gli impiegati sono convinti che la loro produttività aumenti e il tasso d'errori diminuisca riducendo il rumore nell'ambiente in cui operano.
... gli impiegati dei grandi uffici ritengono che il rumore sia il maggiore fattore di disturbo.

EN 60-70%...

... of the students don't understand their teachers properly!
... of the office workers are convinced that they will become more productive and make fewer mistakes when the noise levels in their environment are reduced.
... of the employees in open space offices feel distracted by noise

ES 60-70%...

... los alumnos no oyen a su maestro!
... los empleados de oficina están convencidos de que con menos ruido aumentará su productividad y se reducirá la cuota de defectos.
... los empleados que trabajan en oficinas diáfnas perciben el ruido como el factor de interferencia más importante.

PT 60-70%...

... os professores não entendem bem os alunos!
... os empregados de escritório estão convencidos de que a produtividade aumenta e a taxa de erro diminui se o ruído ambiente for reduzido.
... os funcionários em escritórios em open space consideram o ruído o maior fator parasita.

DE Räume können dank dem Einsatz von SWISSCLIC PANEL-A ihren eigentlichen Nutzen zurückgewinnen.

Die akustische Verbesserung ...

... steigert die Produktivität und Konzentration.
... reduziert Stress und Störungen.
... steigert die Verkäufe in Geschäften.
... bringt Zufriedenheit und ein besseres Wohlbefinden.
... steigert die Sprachverständlichkeit.

FR Grâce à l'utilisation du SWISSCLIC PANEL-A , les pièces peuvent retrouver leur véritable utilité.

L'amélioration acoustique...

... augmente la productivité et la concentration.
... réduit le stress et les dérangements.
... augmente les ventes dans les magasins.
... apporte la satisfaction et un meilleur bien-être.
... augmente la clarté vocale.

IT Grazie all' utilizzo di SWISSCLIC PANEL-A gli ambienti possono recuperare la loro reale funzione.

Il miglioramento acustico ...

... aumenta la produttività e la concentrazione.
... riduce lo stress e i disturbi.
... aumenta le vendite nei negozi.
... porta soddisfazione e regala benessere.
... migliora la comunicazione.

EN Thanks to SWISSCLIC PANEL-A rooms regain their actual benefits.

The acoustic improvement ...

... enhances productivity and concentration.
... reduces stress and distraction .
... increases sales in shops.
... brings satisfaction and greater well being.
... improves the understanding of speech.

ES Gracias al empleo del SWISSCLIC PANEL-A los espacios pueden recuperar su auténtica utilidad.

La mejora acústica...

... aumenta la productividad y concentración.
... reduce el estrés y las interferencias
... incrementa las ventas en las tiendas.
... proporciona satisfacción y más bienestar.
... mejora la inteligibilidad de la comunicación hablada.

PT É possível tirar partido real dos espaços recorrendo ao SWISSCLIC PANEL-A.

A melhoria das condições acústicas...

... aumenta a produtividade e a concentração.
... reduz o stress e os erros.
... aumenta as vendas e os negócios.
... traz satisfação e mais bem-estar.
... aumenta a inteligibilidade ao falar.

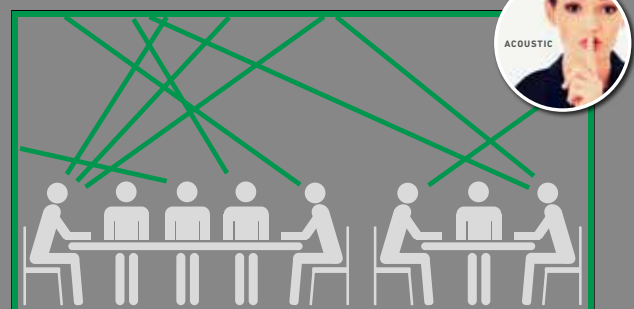
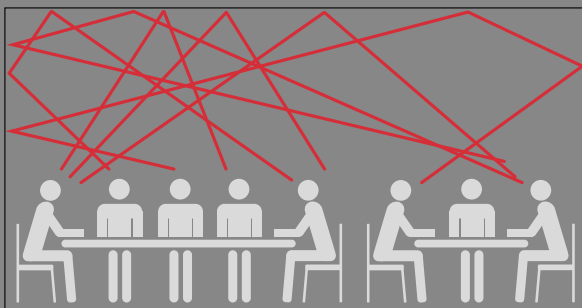

ACOUSTIC SOLUTION



PRACTICE EXAMPLE

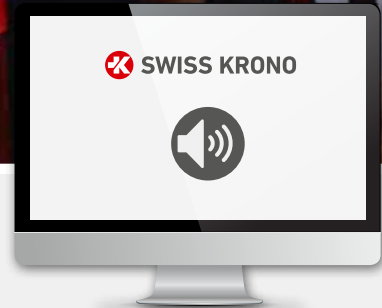

ACOUSTIC CONFIGURATOR
WWW.SWISSKRONO.COM/CH

DIMENSION | Dimensione | Dimensión | dimensão
 10 × 7 × 3 m, 70 m², 210 m³

NUTZUNG | utilisation | utilizzazione | utilização | utilización | utilização
Kantine 35 Sitzplätze | cantine 35 sièges | mensa 35 posto a sedere | canteen 35 seats |
 cantina 35 asiento | cantina 35 assento

	0 M ² SWISSCLIC PANEL-A	100 M ² SWISSCLIC PANEL-A
RAUMGEFÜHL Sensation de pièce Sensazione ambientale Room feeling Impresión por espacio Sensação por espaço	unangenehm désagréable sgradevole inconvenient desagradable desagradável	angenehm agréable piacevole convenient agradable agradável
LÄRMPEGEL Niveau de bruit Livello di rumore Noise level Nivel de ruido	X 46–52 DB	39–45 DB ✓
NACHHALLZEIT Temps de réverbation Tempo di risonanza Reverberation time Tiempo de resonancia Tempo de ressonância	X 1.8–2.3 s	0.4–0.6 s ✓

REFERENCES



SWISSCLIC PANEL-S
D4109 SX



SWISSCLIC PANEL-A
CREATIVE
D5291 OW

ONLINE PRODUCT VIDEO
WWW.SWISSKRONO.COM/CH

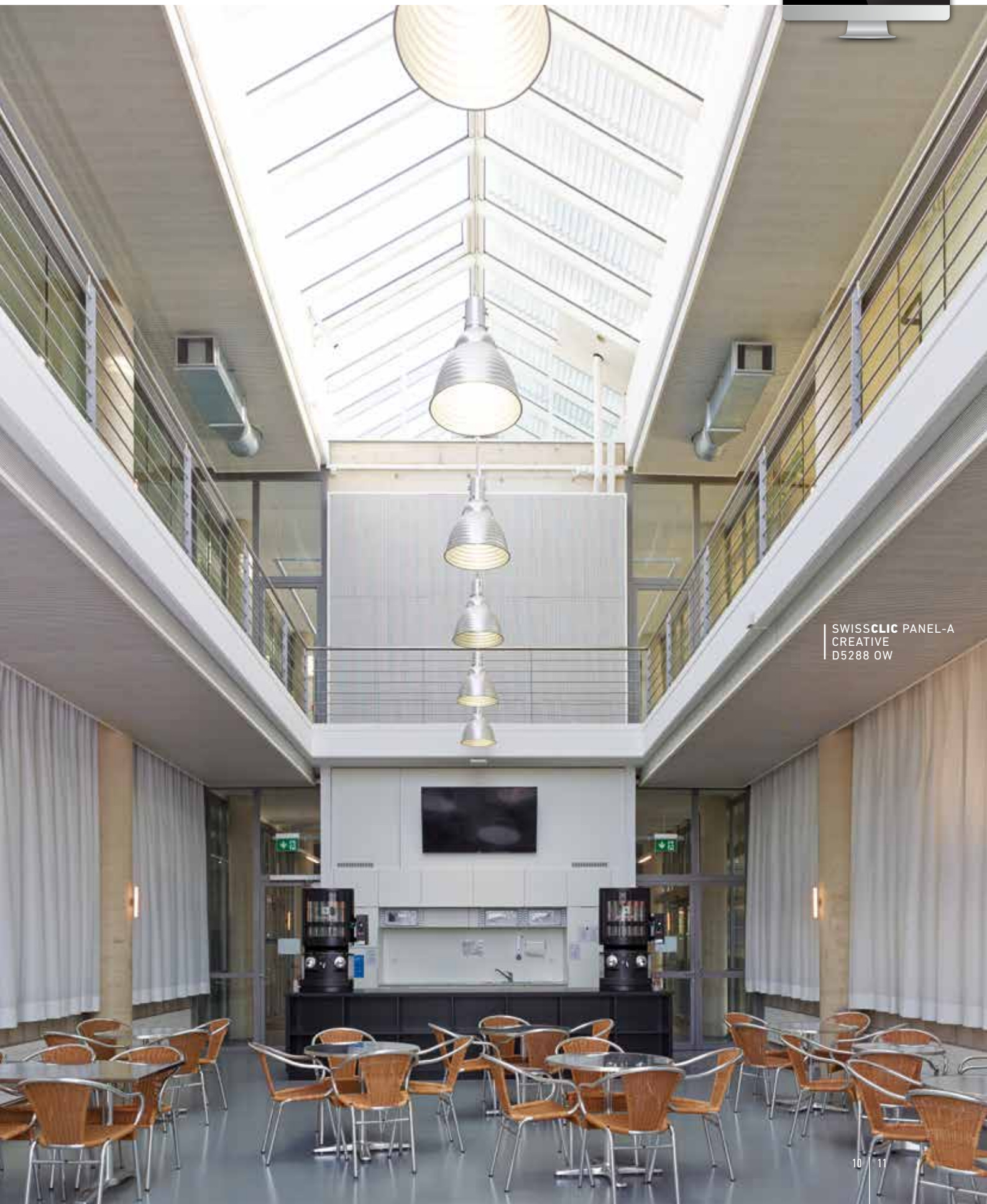
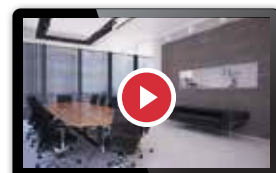

SWISSCLIC PANEL-A
CREATIVE
D5288 OW

DECORS DESIGN

DE Die raue Betonoberfläche D4109 SX wird in der modernen Architektur gerne mit warmen, weichen oder edlen Materialien in Kontrast gesetzt.

FR Dans l'architecture moderne, on aime mettre en contraste la surface de béton rugueuse D4109 SX avec des matériaux nobles chauds et doux.

IT La ruvida superficie effetto cemento D4109 SX è utilizzata nell'architettura moderna per creare un contrasto con i materiali più caldi, morbidi e nobili.

EN The rough concrete surface D4109 SX is preferred as a contrast with warm, soft, and quality materials in modern architecture.

ES En la arquitectura moderna se combina frecuentemente la superficie rugosa tipo hormigón D4109 SX con materiales cálidos, suaves y refinados, para crear un efecto de contraste.

PT A superfície de betão áspera D4109 SX é usada na arquitetura moderna em contrastes felizes com materiais quentes, suaves e nobres.



FRONT WHITE
K101 SX (NCS S 0502-Y)





TEXTIL GREY
D4445 SX

A A+

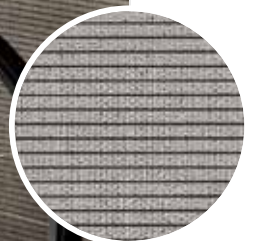
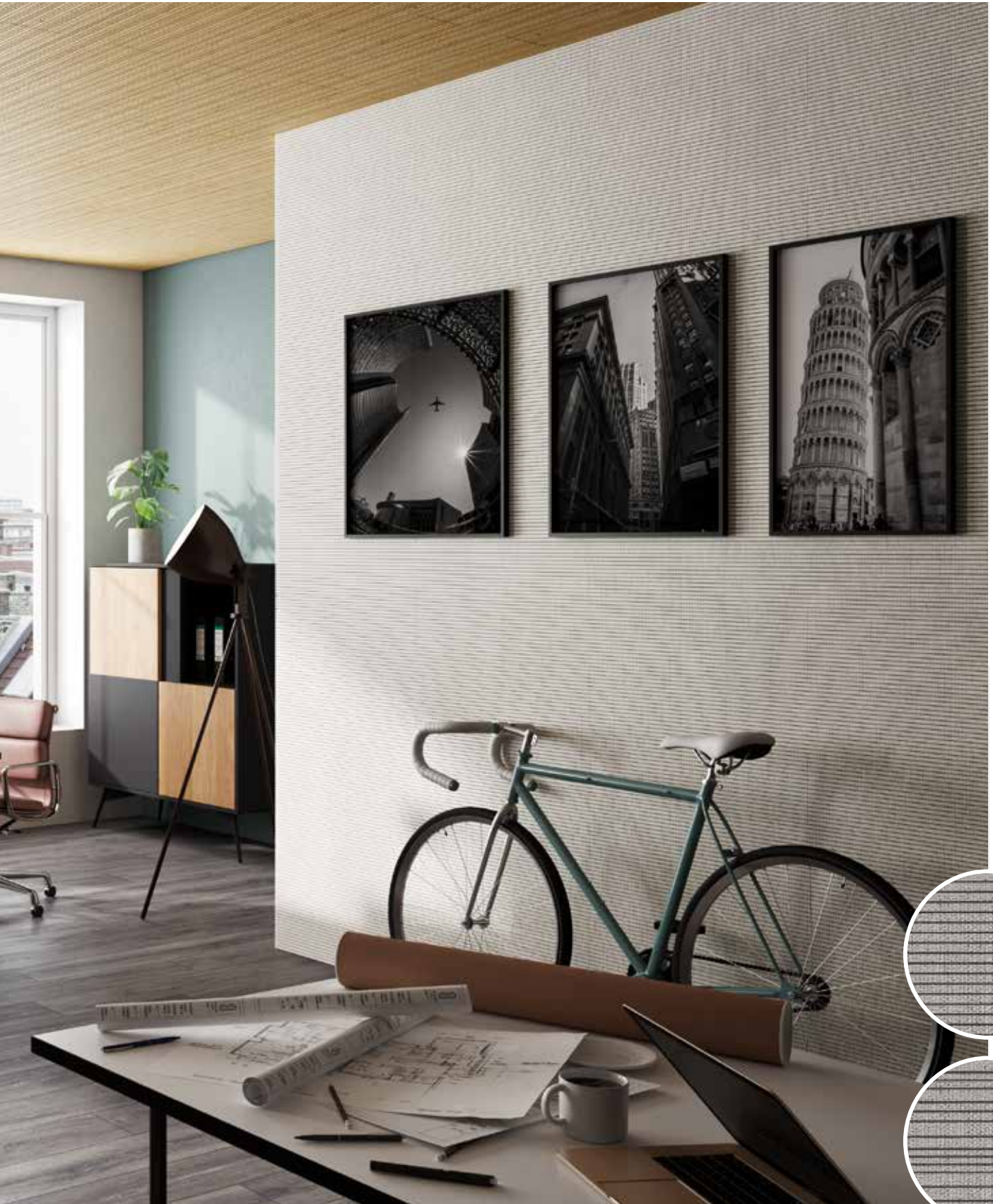

elegant



creative



BETON WOODCON
D4109 SX

S A A+

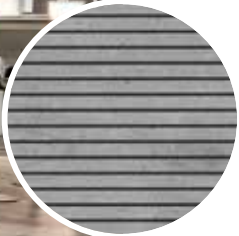

elegant

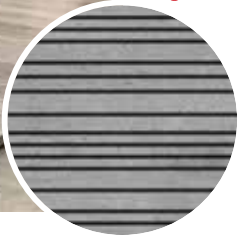

creative



TITAN ANTHRACITE
D4453 OV

A A+



elegant

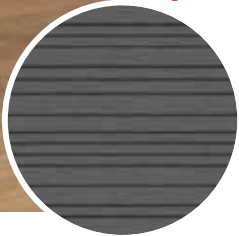

creative

DECORS WOOD

DE SWISSCLIC PANEL Dekore in Holz sind nicht nur das Bild einer massiven Wand- und Deckenverkleidung – mit den Strukturen fühlen sie sich auch so an.

FR Les décors en bois du SWISSCLIC PANEL ne donnent pas seulement l'aspect d'un habillage de mur et de plafond massif, mais grâce à ses structures, on en a l'impression au toucher.

IT I decori SWISSCLIC PANEL in legno non solo presentano l'immagine di un rivestimento in legno massiccio per pareti e soffitti, ma grazie alla loro consistenza risultano tali anche al tatto.

EN SWISSCLIC PANEL wood decors not only present the appearance of solid wall and ceiling panelling their structures also feel like it.

ES Los diseños SWISSCLIC PANEL en madera no sólo reproducen fielmente un revestimiento macizo, mural o de techo – gracias a las texturas producen además la sensación de serlo.

PT Os decors em madeira do SWISSCLIC PANEL não são apenas a imagem de painéis maciços para paredes e tetos, também ao toque as estruturas têm esse efeito.



FRONT WHITE
K101 0W

S A A+



elegant



creative



WHITE SPRUCE
D5288 SD (S) BD (A)

S A A+



elegant



creative



RIVIERA OAK
D5291 OW

S A A+



elegant



creative



SPRUCE
D396 0W

S A A+



elegant

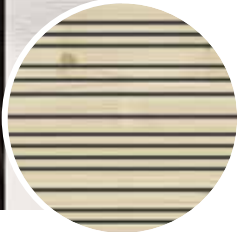

creative



SILVER FIR
D3045 SD (S) BD (A)

S A A+



elegant

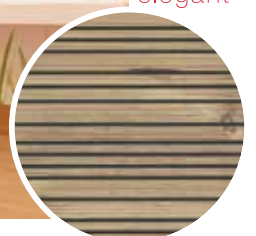

creative

ACCESSORIES

RAIL L NR. 2508



ca./env./cerca
1 pce/m²

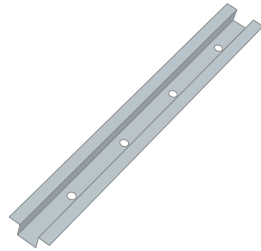

CLIP WS NR. 201 (SWISSCLIC A+ AND S)

ca./env./cerca
5m²/Box

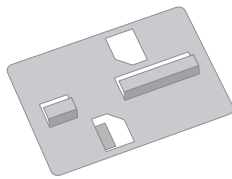

CLIP A NR. 203 (SWISSCLIC A)

ca./env./cerca
5m²/Box

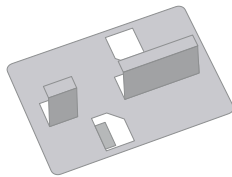

CLIP AWS NR. 202 (SWISSCLIC COMBINATION A AND S)

ca./env./cerca
2.5m²/Box

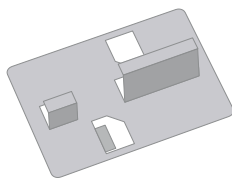

SWISS ABSORBER NR. ZFA001



ca./env./cerca
5.76m²/Box



RAIL H NR. 2518



ca./env./cerca
1 pce/m²

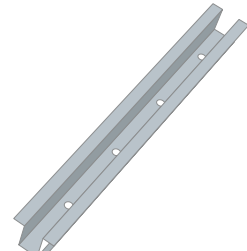

SNAP WS NR. 101 (SWISSCLIC A+ AND S)

ca./env./cerca
1 Box/Room

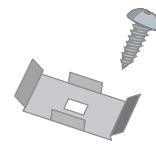

SNAP A NR. 103 (SWISSCLIC A)

ca./env./cerca
1 Box/Room

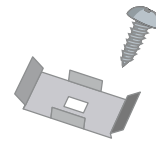

SNAP AWS NR. 102 (SWISSCLIC COMBINATION A AND S)

ca./env./cerca
2 Boxes/Room

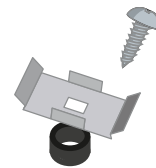

INSTALLATION SWISS ABSORBER

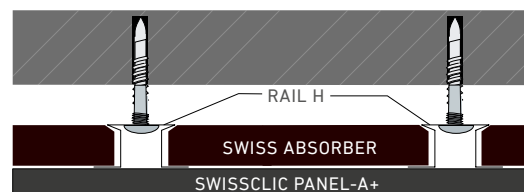

MULTI-MONTI®-plus FIX-B BETONSCHRAUBE

vis béton | vite cemento | cement screw | tornillo concreto

Nr. 4614

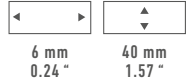

6 mm 40 mm
0.24" 1.57"

ca./env./cerca
20m²/Box

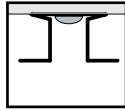
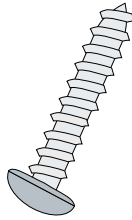

FIX-W WANDSCHRAUBE

vis murale | vite muro | wall screw | tornillo muro

Nr. 5615



6 mm 50 mm
0.24" 1.97"

ca./env./cerca
50m²/Box

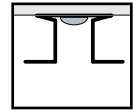

FIX-M DISTANZSCHRAUBE

vis distance | vite distanza | spacer screw | tornillo distancia

Nr. 4626

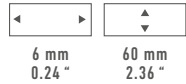

6 mm 60 mm
0.24" 2.36"

ca./env./cerca
20m²/Box

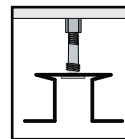
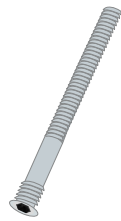

FIX-H DISTANZSCHRAUBE

vis distance | vite distanza | spacer screw | tornillo distancia

Nr. 5626

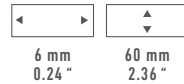

6 mm 60 mm
0.24" 2.36"

ca./env./cerca
20m²/Box

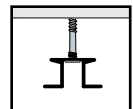
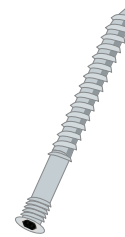

ADAPTER SYSTEM NONIUS NR. 301

für | pour | per | para RAIL H

ca./env./cerca
20m²/Box

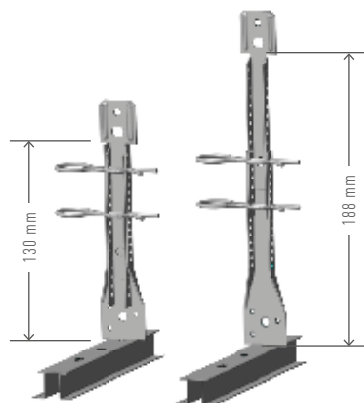

DISTANCE HOLDER NR. 330

ca./env./cerca
20m²/Box

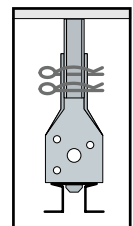
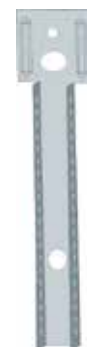

ACCESSORIES

END & DILATATION PROFILE ALUMINIUM

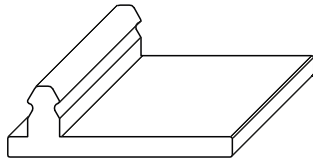

END PROFILE

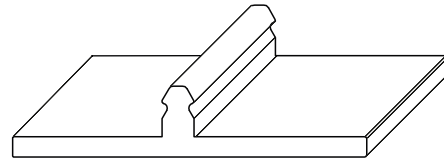
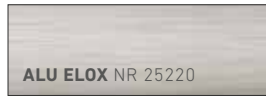
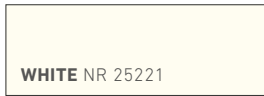

DILATATION PROFILE

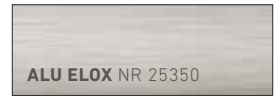
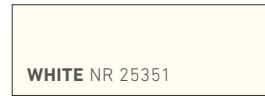

BASE PROFILE ALUMINIUM

WS Nr. 2560



A Nr. 2570

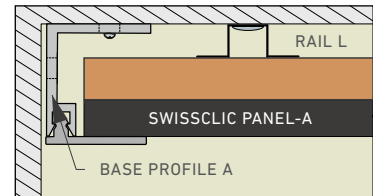
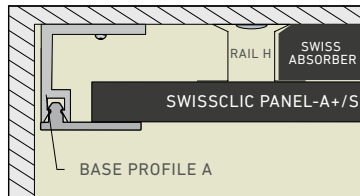
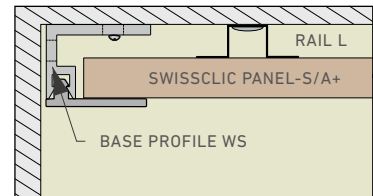
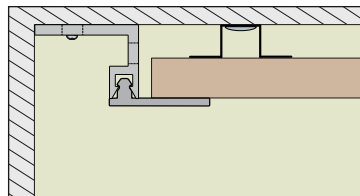
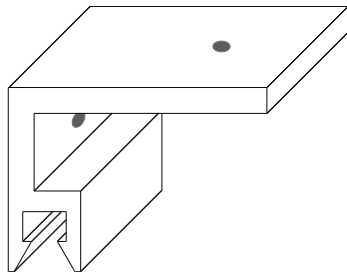

CORNER PROFILE ALUMINIUM



CORNER PROFILE WS
WHITE NR 25251

CORNER PROFILE WS
ALU ELOX NR 25250



CORNER PROFILE A
WHITE NR 25301

CORNER PROFILE A
ALU ELOX NR 25300

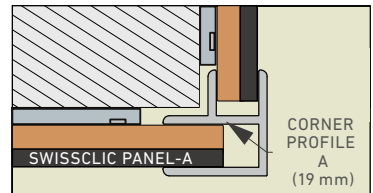
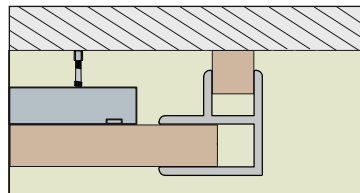
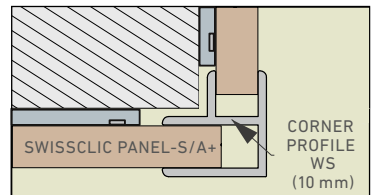
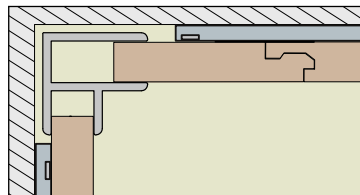
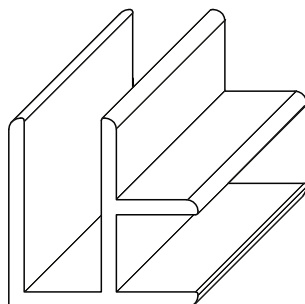

TOOLS



ONLINE-TOOLS WWW.SWISSKRONO.COM/CH

-  PRODUCT VIDEO
-  INSTALLATION VIDEO
-  INTERIOR STUDIO
-  CALCULATOR
-  ACOUSTIC CONFIGURATOR

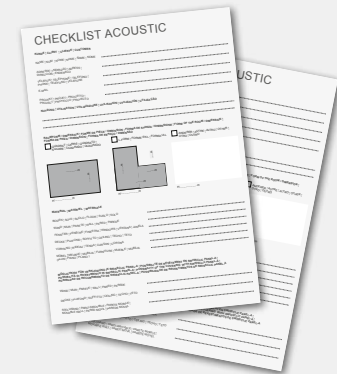

CHECKLIST ACOUSTIC
PDF-DOWNLOAD ON
WWW.SWISSKRONO.COM/CH



INSTALLATION GUIDE

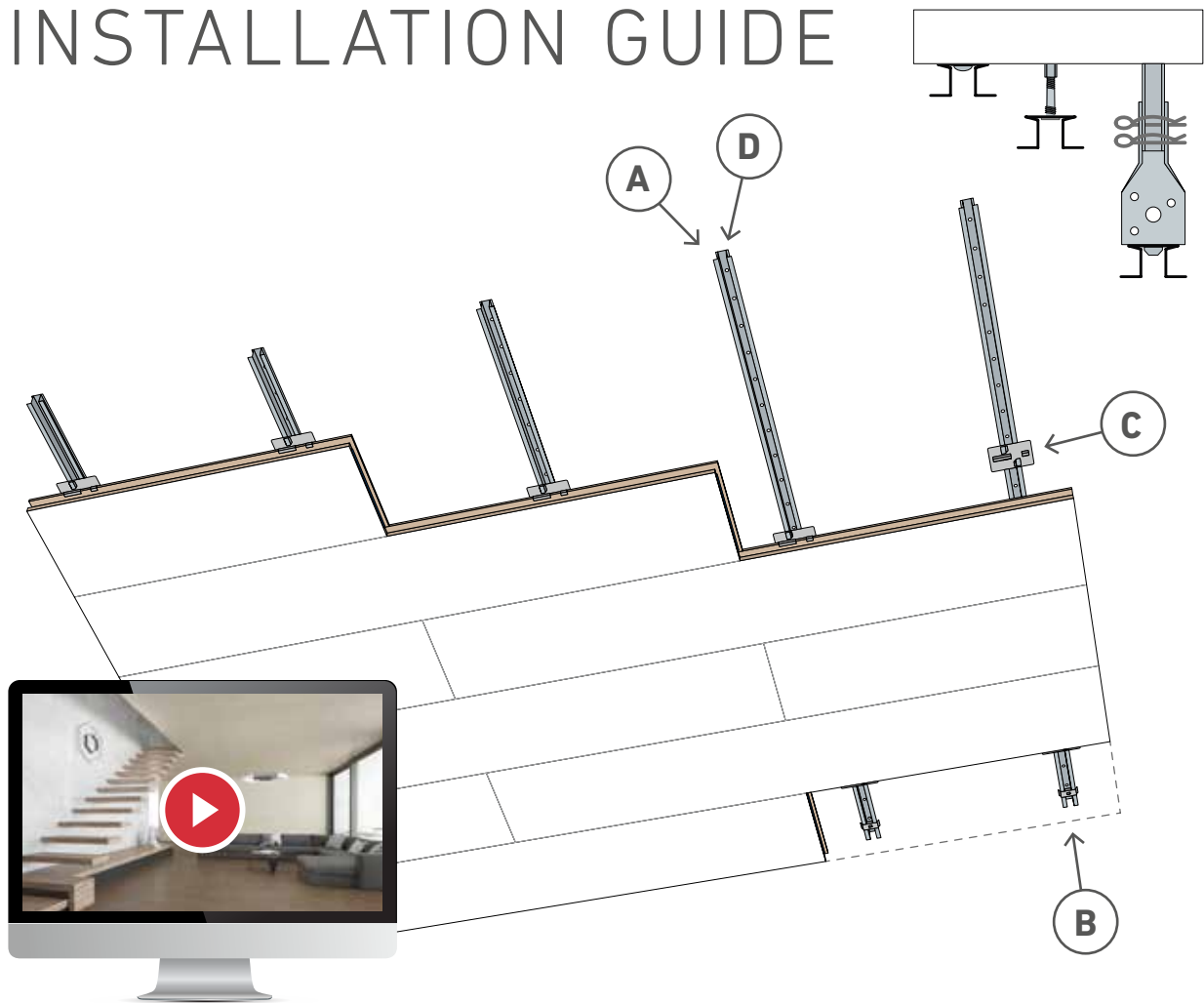

ONLINE-INSTALLATION VIDEO
WWW.SWISSKRONO.COM/CH

SIMPLE AND RAPID

<p>1</p>	<p>2</p>	<p>3 48 h >18°C / 64°F <70%</p>	<p>4</p>
<p>5</p>	<p>6</p>	<p>7</p> <p>① < 12 m ② < 8 m</p>	

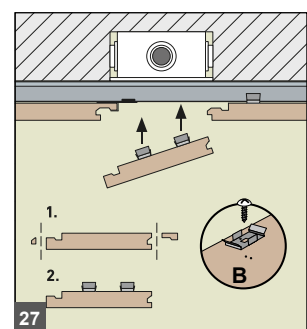
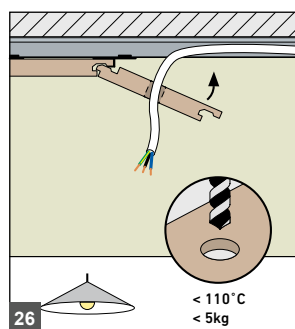
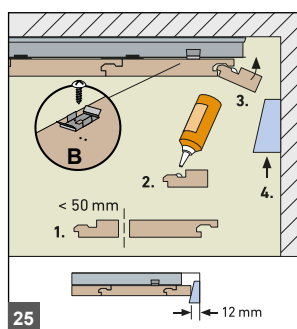
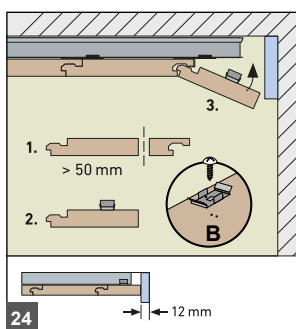
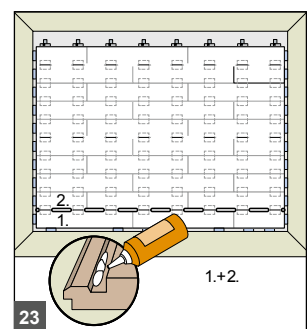
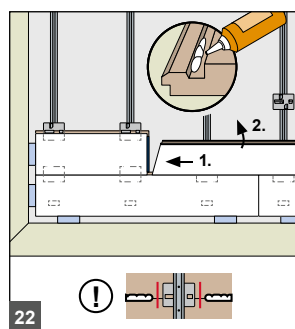
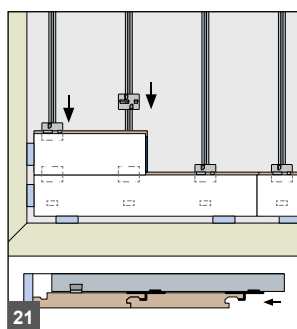
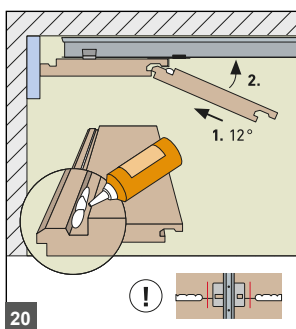
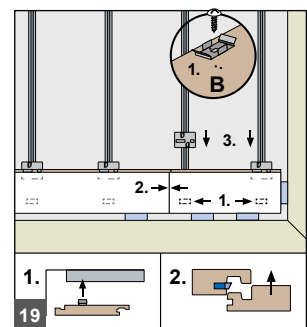
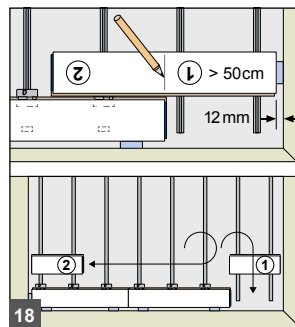
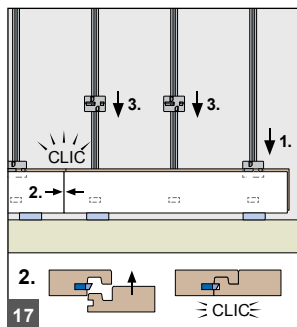
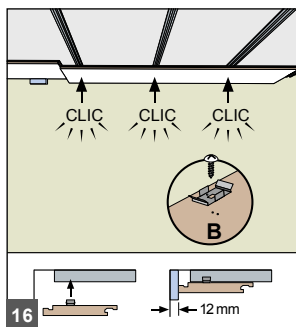
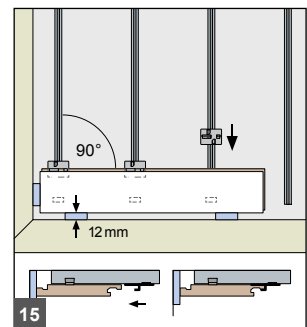
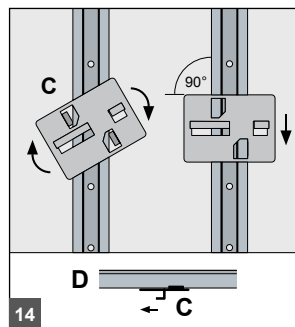
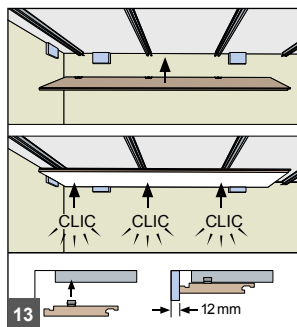
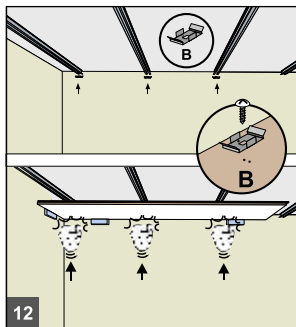
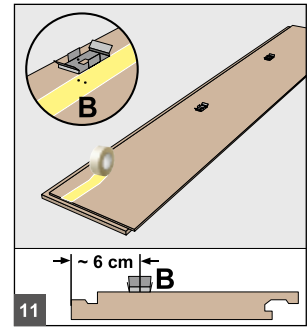
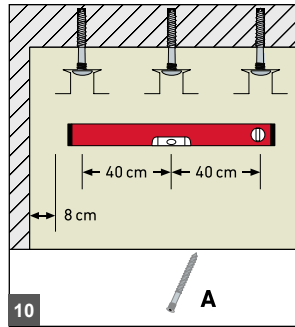
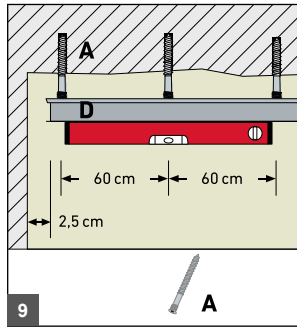
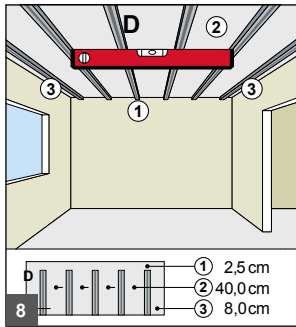

PACKING UNITS

SWISSCLIC PANEL-S



1 Box = 7 Paneelen = 1.81 m² / 16 kg
1 box = 7 panels = 19.48 sqft / 35.28 pounds



56 Boxen = 101.36 m² / 896 kg
56 boxes = 1091.03 sqft / 1974 pounds

SWISSCLIC PANEL-A



1 Box = 4 Paneelen = 1.03 m² / 8.78 kg
1 box = 4 panels = 11.08 sqft / 19.36 pounds



48 Boxen = 49.44 m² / 421.44 kg
48 boxes = 532.16 sqft / 929.12 pounds

RAIL L NR. 2508



1 Box = 10 Stück = 5 kg
1 box = 10 pieces = 11.02 pounds



80 Boxen = 400 kg
80 boxes = 881.84 pounds

SWISS ABSORBER NR. ZFA001



1 Box = 12 Stück = 5.76 m² / 8.81 kg
1 box = 12 pieces = 62.00 sqft / 19.43 pounds



22 Boxen = 126.72 m² / 193.82 kg
22 boxes = 1364.00 sqft / 427.46 pounds

CLIP



1 Box WS/A = 60 Stück | pieces
1 Box AWS = 30 Stück | pieces

SNAP



1 Box = 30 Stück | pieces

SWISSCLIC PANEL-A+



1 Box = 8 Paneelen = 2.06 m² / 16.70 kg
1 box = 8 panels = 22.17 sqft / 36.82 pounds



48 Boxen = 99.1 m² / 799.68 kg
48 boxes = 1066.7 sqft / 1762.99 pounds

SWISSCLIC ELEMENT-A



1 Box = 39 kg
1 box = 85.98 pounds



10 Boxen = 390 kg
10 boxes = 859.8 pounds

RAIL H NR. 2518



1 Box = 10 Stück = 8 kg
1 box = 10 pieces = 17.63 pounds

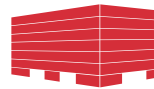

80 Boxen = 640 kg
80 boxes = 1410.95 pounds

BASE & END PROFILE



1 Box = 6 Stück | pieces

CORNER PROFILE



1 Box = 2 Stück | pieces

DIREKT MONTAGE | montage direct | montaggio diretto | direct installation | montaje directo | montagem directo

MULTI-MONTI®-plus FIX-B BETONSCHRAUBE

vis béton | vite cemento | cement screw | tornillo concreto



1 Box = 100 Stück | pieces

FIX-W WANDSCHRAUBE

vis murale | vite muro | wall screw | tornillo muro



1 Box = 250 Stück | pieces

DISTANZ MONTAGE | montage distance | montaggio distanza | distance installation | montaje distante | montagem distância

FIX-M DISTANZSCHRAUBE

vis distance | vite distanza | spacer screw | tornillo distancia



1 Box = 100 Stück | pieces

FIX-H DISTANZSCHRAUBE

vis distance | vite distanza | spacer screw | tornillo distancia







1 Box = 100 Stück | pieces

ADAPTER SYSTEM NONIUS



1 Box = 100 Stück | pieces

OVERVIEW

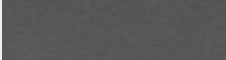
DECOR Décor Decoro		SEITE Page Pagina	PANEL-A+ CREATIVE	PANEL-A+ ELEGANT	PANEL-A* CREATIVE	PANEL-A* ELEGANT	ELEMENT-A* CREATIVE	ELEMENT-A* ELEGANT	PANEL-S
	K101 SX	13							●
	K101 OW	19	●	●	●	●	●	●	●
	D5288 SD (BD)	20	●	●	●	●	●	●	●
	D396 OW	22	●	●	●	●	●	●	●
	D3045 SD (BD)	23	●	●	●	●	●	●	●
	D5291 OW	21	●	●	●	●	●	●	●
	D4445 SX	14	●	●					
	D4109 SX	16	●	●	●	●	●	●	●
	D4453 OV	17	●	●					

- * **DE** Solange Vorrat
- FR** Jusqu'à épuisement des stocks
- IT** Fino ad esaurimento scorte
- EN** While stocks last
- ES** Hasta fin de existencias
- PT** Limitado ao Stock existente

DE Lieferung, Garantie und Haftung gemäss Verkaufs- und Lieferbedingungen der SWISS KRONO AG. Bitte beachten Sie die lokalen Bauvorschriften.

FR Livraison, garantie et responsabilité selon condition de vente et de livraison de SWISS KRONO SA. Prière de respecter les directives de construction locales.

IT Consegna, garanzia e responsabilità ai sensi delle condizioni di vendita e fornitura di SWISS KRONO SA. Si prega di considerare il regolamento di costruzione locale.

EN Delivery, warranty and liability according to the terms and conditions of sales and delivery of SWISS KRONO AG. Please read and follow the regional building regulations.

ES Entrega e garantía de acuerdo a condiciones de venta y entrega de SWISS KRONO AG. Por favor tenga en cuenta el normativa de obras local.

PT Entrega, garantia e responsabilização pelos produtos conforme as condições de venda da Swiss Krono AG. Por favor respeite as normas de construção.



Das Zeichen für verantwortungsvolle Waldbirtschaft
Fragen Sie nach FSC-zertifizierten Produkten

INTERIOR



ONE WORLD
SWISS COLLECTION



BE.YOND



SWISSCDF



SWISS FLOORS

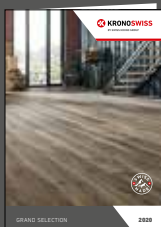

GRAND SELECTION



HELVETIC FLOORS



SWISSDIGITAL



SWISSFANTASY



VERBUNDPLATTEN
PANNEAUX COMPOSITES
PANNELLI COMPOSITI
LAMINATE BONDED BOARDS

SWISS KRONO-Welt | L'univers SWISS KRONO | Mondo SWISS KRONO | SWISS KRONO-World

SWISS KRONO AG
Willisauerstrasse 37
6122 Menznau
Schweiz

T +41 41 494 94 94
F +41 41 494 94 49

chme.info@swisskrono.ch
www.swisskrono.com/ch

